



SMART10 A/Z

CONTINUOUS LINE OF LIGHT IN A SMALL OVERALL DIMENSIONS



- decorative and lighting profile
- continuous line of light (when using LED strip 120 P/m and white cover)
- SLICK socket
- miniature dimensions
- universal application
- the possibility of using waterproof LED strips
- maximum width of LED strip: 10 mm



SIMILAR IN THE OFFER



SLIM8
A/Z



SMART-IN10
A/Z



SURFACE10
BC/UX



BEGTON12
J/S



SURFACE14
EF/TY

SMART10 A/Z

A slide cover

Z¹ Z flexible mounting plate

Z² cone Z flexible mounting plate

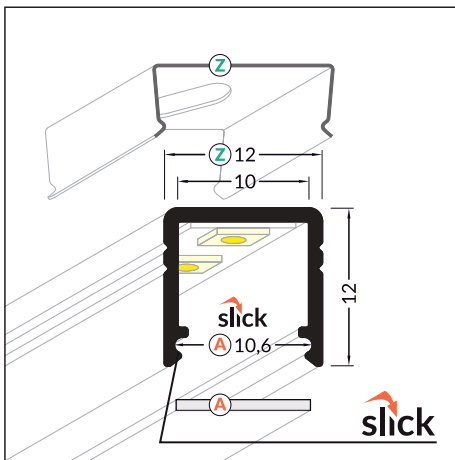
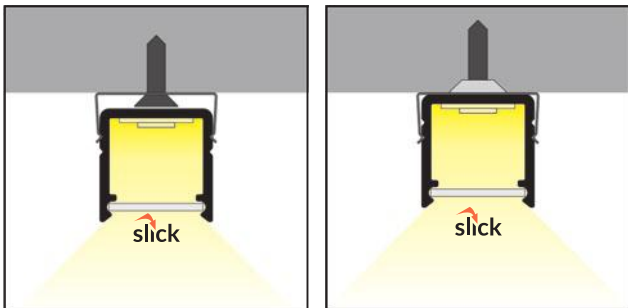
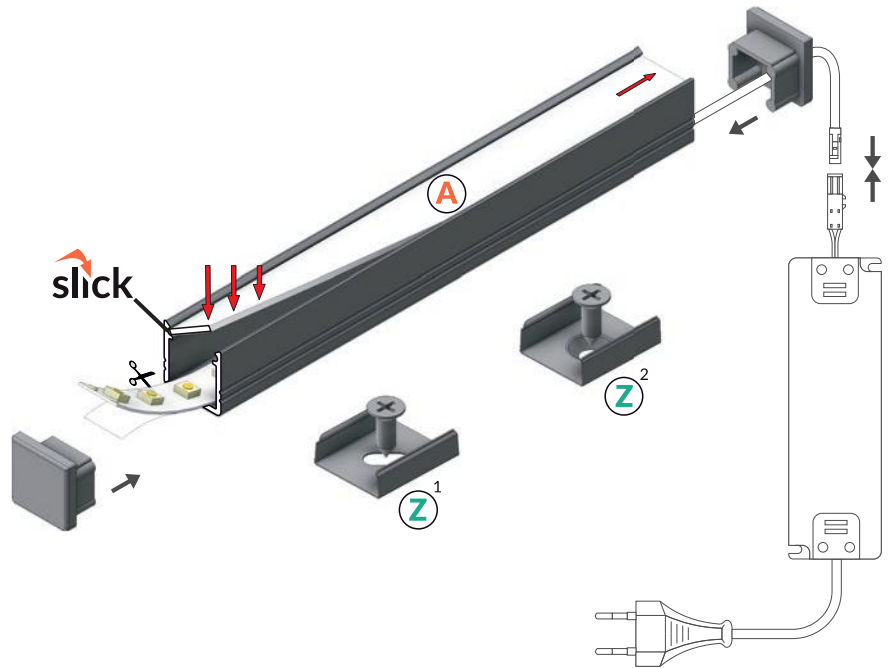

 max 10 mm

 surface



INDEX = 1 pc, length 2000 mm
package = 10 pcs

 white painted
C2020001

 anodized
C2020020

 black anodized
C2020021

 raw aluminium
C2020000

Available lengths
1000 mm, 2000 mm, 3000 mm, 4000 mm



COVERS

A slide cover
 colours: transparent, frosted, white
 material: PC, PP, PP



Note! Dimensions of the space to install LED source

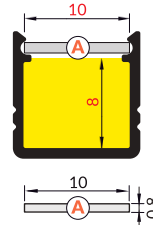

INDEX = 1 pc, length 2000 mm
 package = 10 pcs

A transparent
 89070016

A frosted
 89070039

A white
 89070038

ENDINGS

SMART10 ending
 colours: white, silver, black, grey
 material: ABS

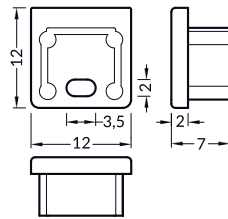

SMART10 ending with hole
 colours: white, silver, black, grey
 material: ABS

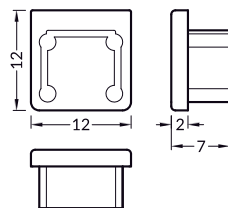

INDEX = 1 set
 package of 10 sets = 20 pcs

white
 without hole | with hole
 C2940001 | C2960001

silver
 without hole | with hole
 C2940040 | C2960040

black
 without hole | with hole
 C2940002 | C2960002

grey
 without hole | with hole
 C2940022 | C2960022

MOUNTINGS

Z flexible mounting plate
 colours: white, inox, black
 material: stainless steel

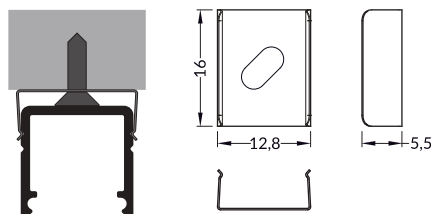

cone Z flexible mounting plate
 colours: white, inox, black
 material: stainless steel

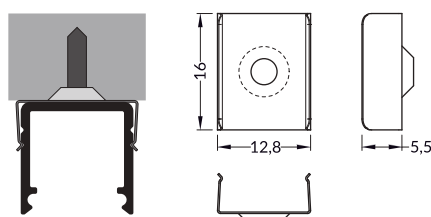

INDEX = 1 set
 package of 10 sets = 20 pcs

Z flexible mounting plate

white 89270001

inox 89270019

black 89270002

cone Z flexible mounting plate

white 89980001

inox 89980019

black 89980002

ACCESSORIES

Available in stock



CONNECTORS

SMART10 connector 90 deg
colours: white, anodized, black
material: aluminium

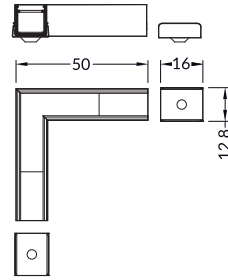

INDEX = 1 set

 white painted
C2910001

 anodized
C2910020

 black anodized
C2910021



 Made in Poland

 EU-registered industrial design